

| | | | | |
|--|---------------------|--|--------------------------------------|---------------|
| | BRAND: HEADON | STYLE NAME: LONG SLEEVE T-SHIRT WITH EYELET DETAIL | PATTERN: | 1ST PROTO |
| | BUYER: | STYLE NUMBERS: | SIZE RANGE: XS - XL PROTO SIZE: S | |
| | PRODUCT TECHNICIAN: | SEASON: FW 25 | DATE LAST MODIFIED: 19/03/2025 | STYLE DETAILS |

PRODUCT DESCRIPTION

LONG SLEEVE T-SHIRT WITH EYELET DETAILS ON SLEEVES SHOULDER AND RIGHT FRONT. STRIPS OF COTTON JERSEY FABRICS INTERWOVEN THROUGH THE EYELETS AND DRAPING DOWN THE GARMENT.

COLORWAY:

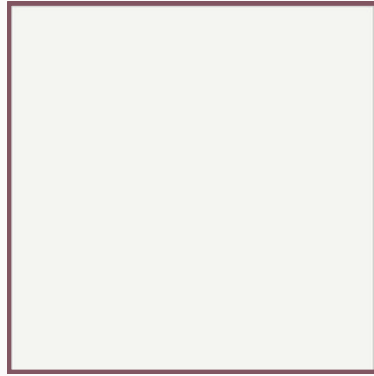

FRONT VIEW
BACK VIEW

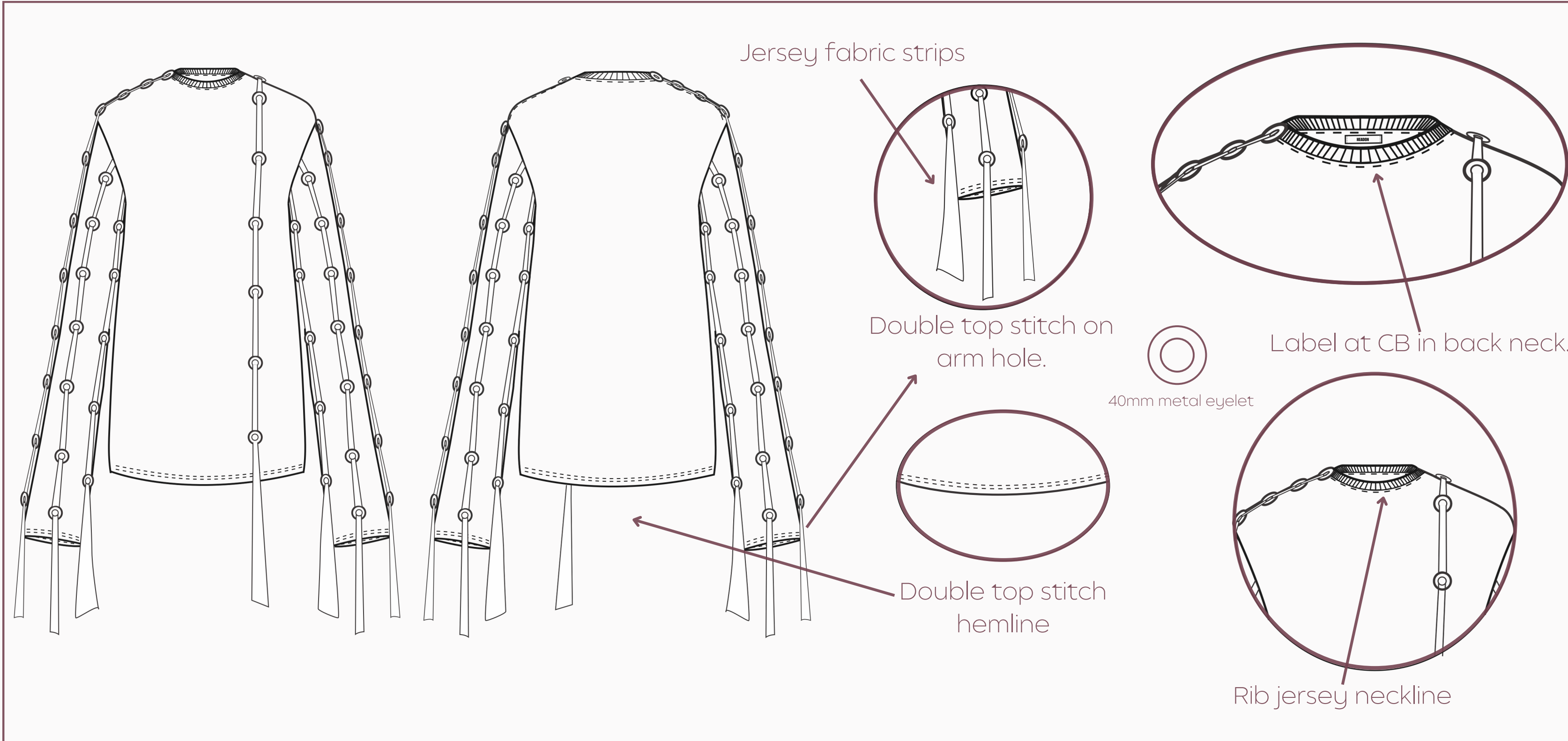



| | | | | | |
|--------------|-------------------------|------------|---------------|--------|--------|
| | FABRIC 1 | FABRIC 2 | ACCESSORIES: | TRIMS: | NOTES: |
| REF* | COTTON JERSEY | RIB JERSEY | METAL EYELETS | | |
| COMPOSITION* | 100% COTTON | | | | |
| WEIGHT* | | | | | |
| PLACEMENT* | BODY | NECKLINE | | | |
| THREAD | 100% POLYESTER DTM BODY | | | | |

| | | | | |
|--|---------------------|---|--------------------------------------|---------------|
| | BRAND: HEADON | STYLE NAME: EYELET DETAIL PUFFER JACKET | PATTERN: | 1ST PROTO |
| | BUYER: | STYLE NUMBERS: | SIZE RANGE: XS - XL PROTO SIZE: S | |
| | PRODUCT TECHNICIAN: | SEASON: FW 25 | DATE LAST MODIFIED: 19/03/2025 | STYLE DETAILS |

PRODUCT DESCRIPTION

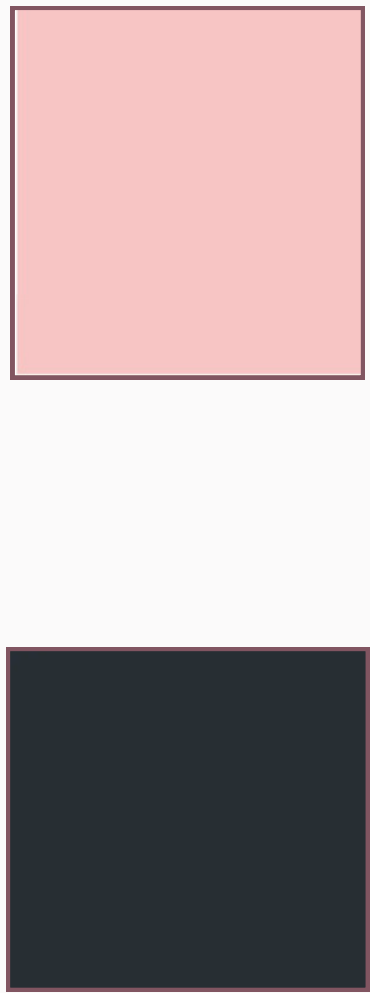
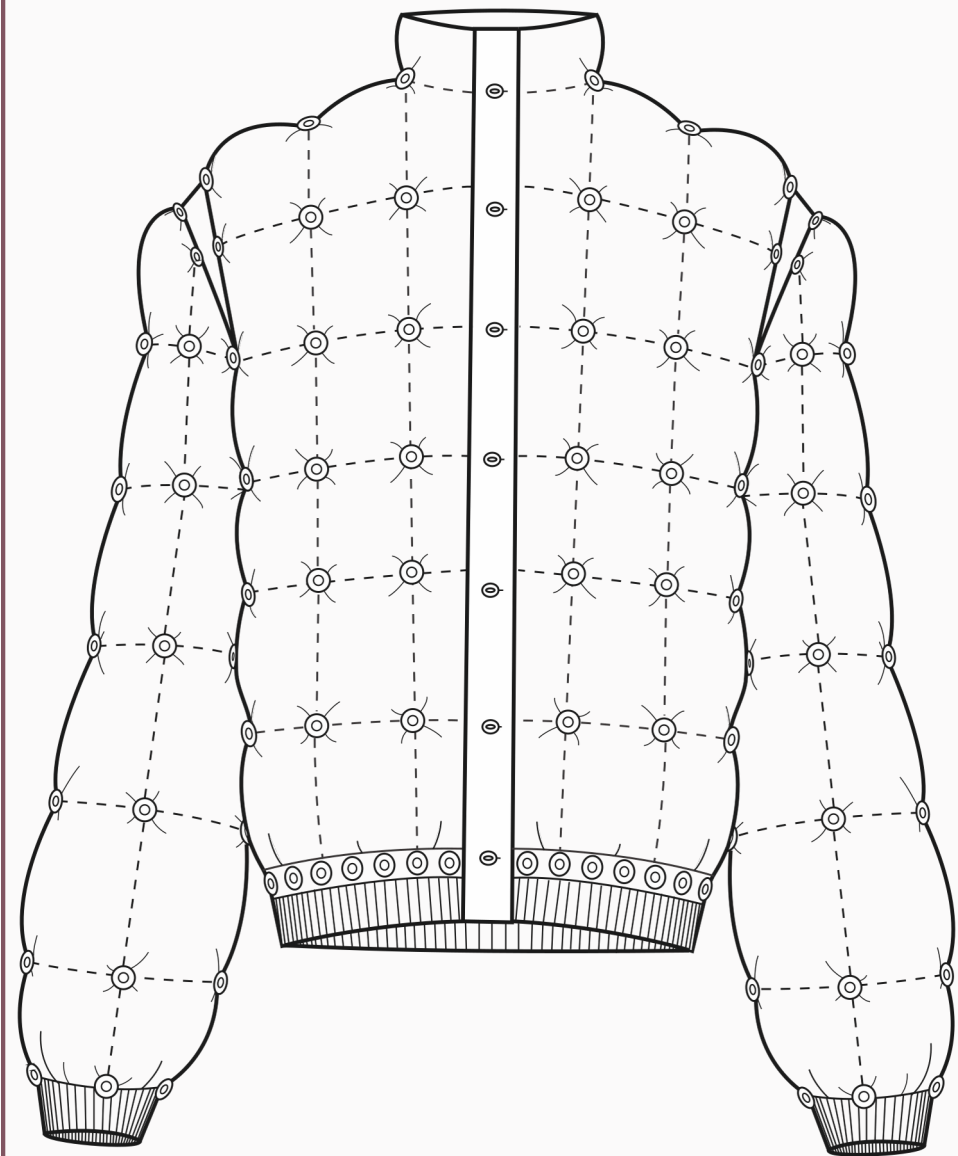
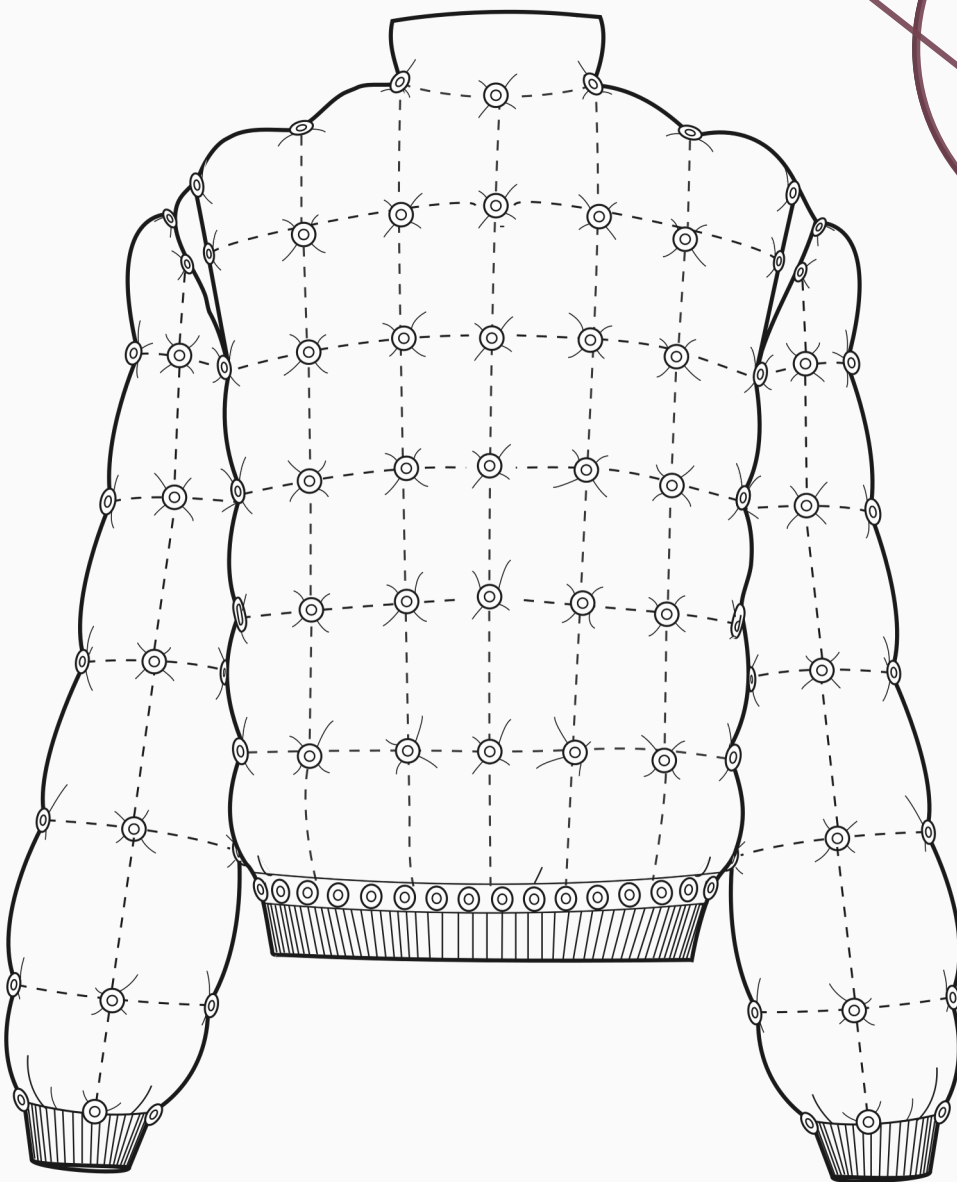
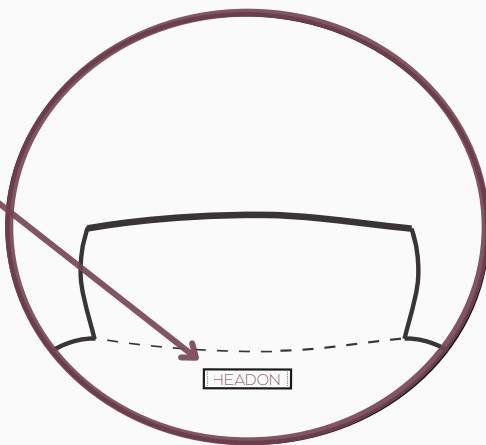
CALFSKIN LEATHER PUFFER WITH EYELET DETAILS WITH RIBBED CUFF AND HEMS.

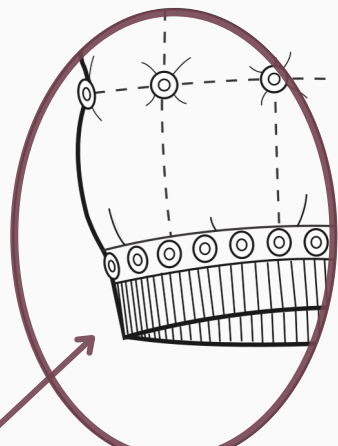
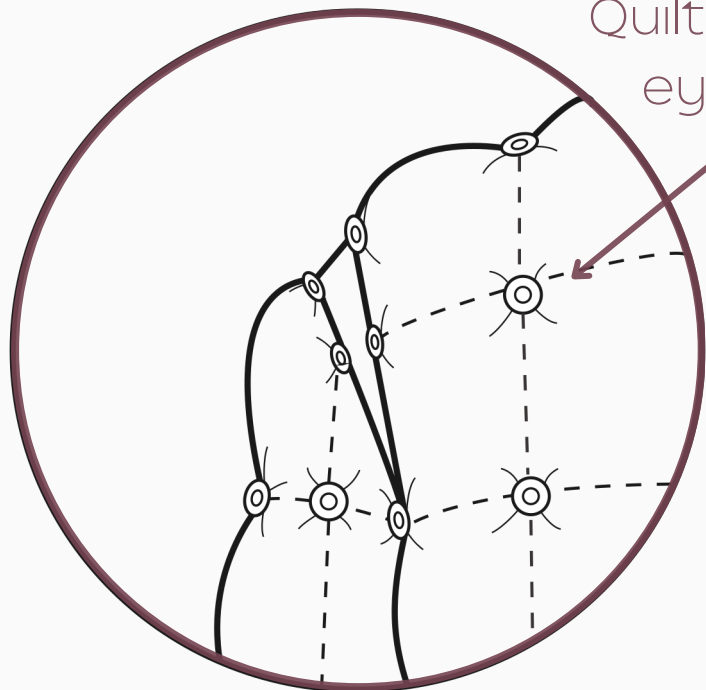
| | FRONT VIEW | BACK VIEW | DETAILS | |
|---|---|---|---|--|
| <p>COLORWAY:</p>  |  | <p>Label on CB</p>  |  <p>Buttoning placket with zipper underneath</p> |  <p>40 mm metal eyelet</p> |
| | | |  <p>Ribbed hemline on cuffs</p> |  <p>Quilting with eyelets</p> |

| | FABRIC 1 | FABRIC 2 | ACCESSORIES: | TRIMS: | NOTES: |
|--------------|-------------------------|-----------|--------------|--------|--------|
| REF* | CALFSKIN LEATHER | SILK | 40MM EYELETS | | |
| COMPOSITION* | 100% LEATHER | 100% SILK | | | |
| WEIGHT* | | | | | |
| PLACEMENT* | BODY | LINING | | | |
| THREAD | 100% POLYESTER DTM BODY | | | | |

| | | | | |
|--|---------------------|---|---|---------------|
| | BRAND: HEADON | STYLE NAME: LEATHER PANTS WITH EYELET DETAILS | PATTERN: | 1ST PROTO |
| | BUYER: | STYLE NUMBERS: | SIZE RANGE: EU 32 - 44 PROTO SIZE: EU 34 | |
| | PRODUCT TECHNICIAN: | SEASON: FW 25 | DATE LAST MODIFIED: 19/03/2025 | STYLE DETAILS |

PRODUCT DESCRIPTION

CALFSKIN LEATHER PANTS WITH 2 VARYING METAL EYELET SIZES

FRONT VIEW

BACK VIEW

COLORWAY:

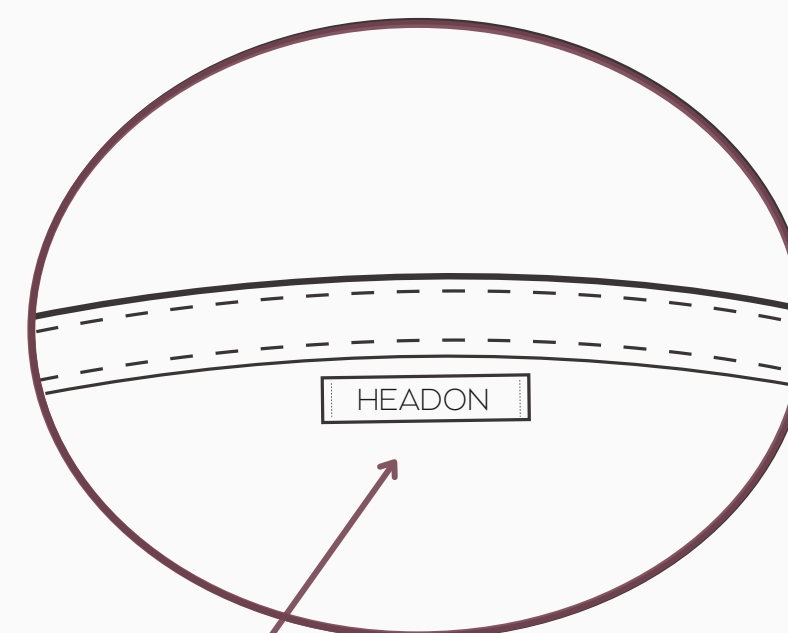
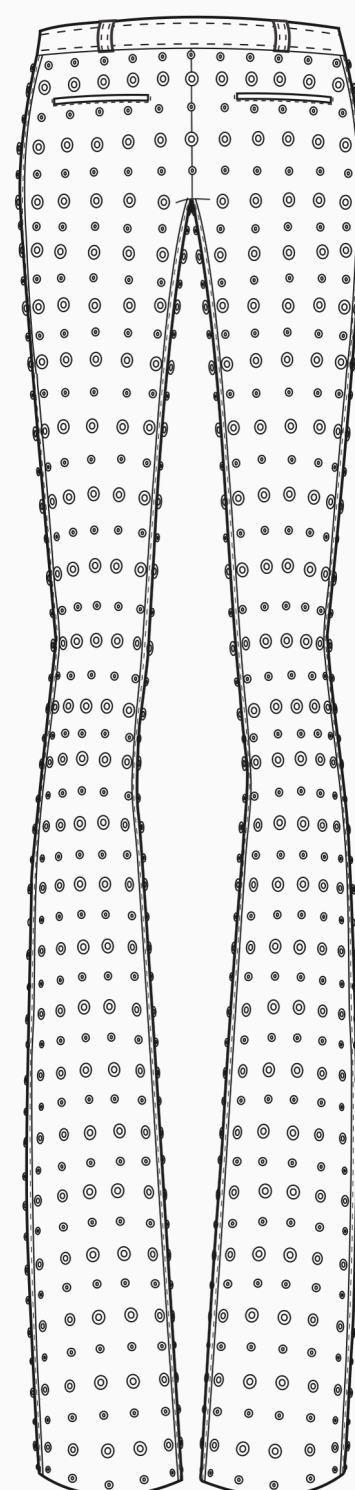
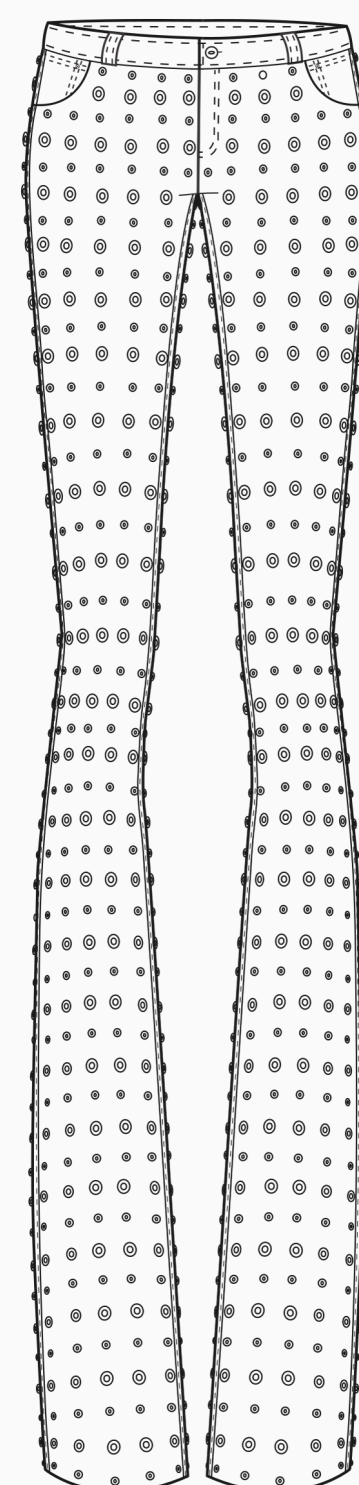
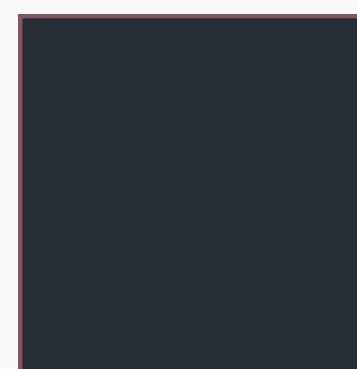
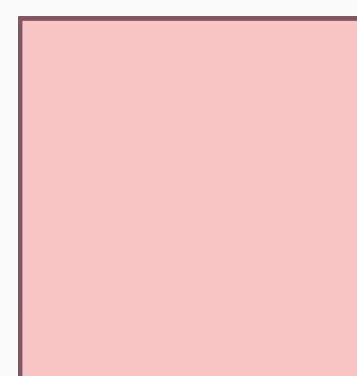

Label at CB below waistband

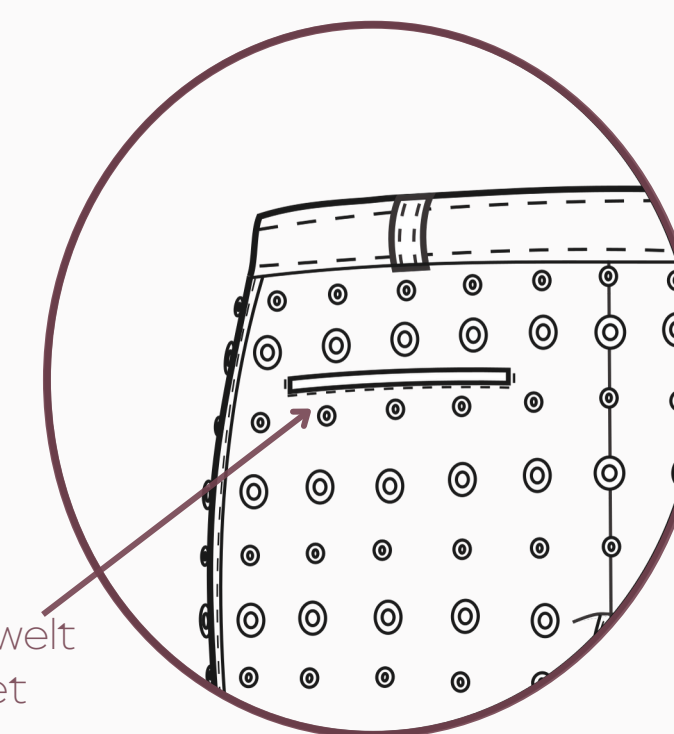

Top stitched welt back pocket

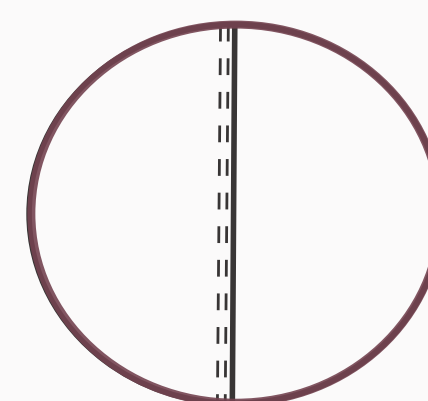

Double top stitch side seams

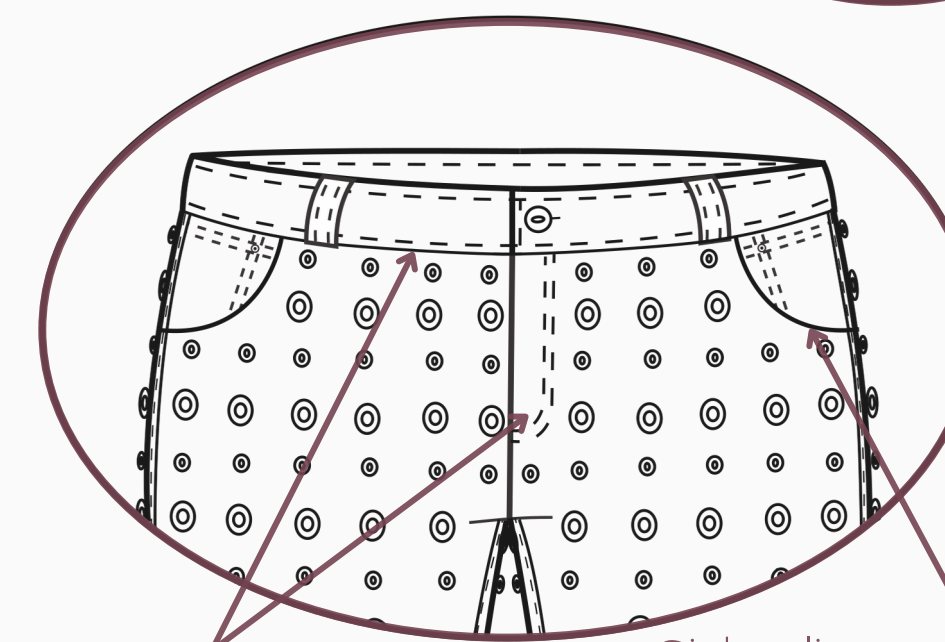

2 parallel top stitches on waistband and belt loops and double stitched fly tab

Side slit pockets with inner double top stitch detail

40 mm metal eyelet



18 mm metal eyelet



| | FABRIC 1 | FABRIC 2 | ACCESSORIES: | TRIMS: | NOTES: |
|--------------|-------------------------|-----------|--|--------|--------|
| REF* | CALFSKIN LEATHER | SILK | 40MM METAL EYELET 18MM METAL EYELET | | |
| COMPOSITION* | 100% LEATHER | 100% SILK | | | |
| WEIGHT* | | | | | |
| PLACEMENT* | BODY | LINING | | | |
| THREAD | 100% POLYESTER DTM BODY | | | | |

| | | | | |
|--|---------------------|---|--------------------------------------|---------------|
| | BRAND: HEADON | STYLE NAME: LEATHER CORSET WITH EYELET DETAIL | PATTERN: | 1ST PROTO |
| | BUYER: | STYLE NUMBERS: | SIZE RANGE: XS - XL PROTO SIZE: S | |
| | PRODUCT TECHNICIAN: | SEASON: FW 25 | DATE LAST MODIFIED: 19/03/2025 | STYLE DETAILS |

PRODUCT DESCRIPTION

CALFSKIN LEATHER CORSET WITH EYELET DETAILS AND SUED STRIPS DRAPING VERTICALLY.

COLORWAY:

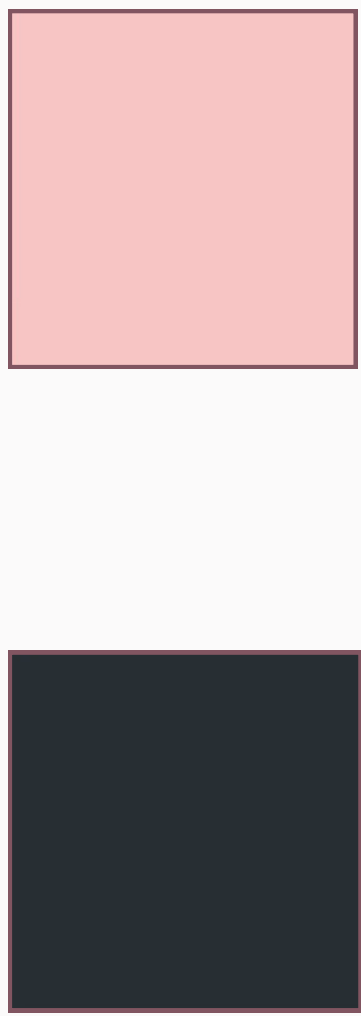

FRONT VIEW
BACK VIEW

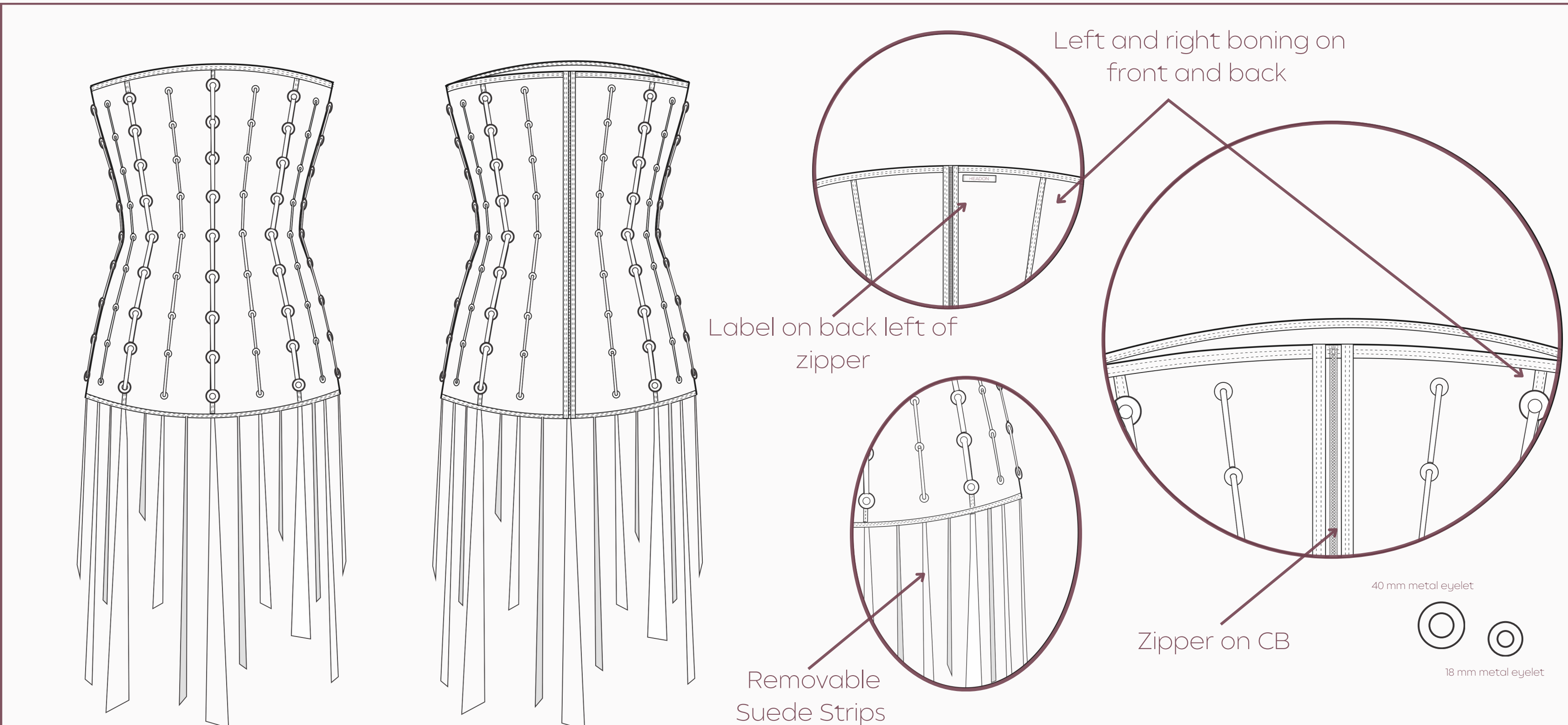

| | FABRIC 1 | FABRIC 2 | ACCESSORIES: | TRIMS: | NOTES: |
|--------------|-------------------------|-----------|--|--------|--------|
| REF* | CALFSKIN LEATHER | SILK | 40MM METAL EYELET 18MM METAL EYELET | | |
| COMPOSITION* | 100% LEATHER | 100% SILK | | | |
| WEIGHT* | | | | | |
| PLACEMENT* | BODY | LINING | | | |
| THREAD | 100% POLYESTER DTM BODY | | | | |

| | | | | |
|--|------------------------|---|--------------------------------|---------------|
| | BRAND: A POINT OF VIEW | STYLE NAME: MINI DRESS WITH TEAR DROP EMBELLISHMENT | PATTERN: | 1ST PROTO |
| | BUYER: | STYLE NUMBERS: | SIZE RANGE: PROTO SIZE: | |
| | PRODUCT TECHNICIAN: | SEASON: SS 25 | DATE LAST MODIFIED: 25/05/2025 | STYLE DETAILS |

PRODUCT DESCRIPTION

MINI DRESS WITH DEEP PLUNGING NECKLINE AND VERTICALLY STITCHED BEADS FOR A TEAR DROP EFFECT

FRONT VIEW

BACK VIEW

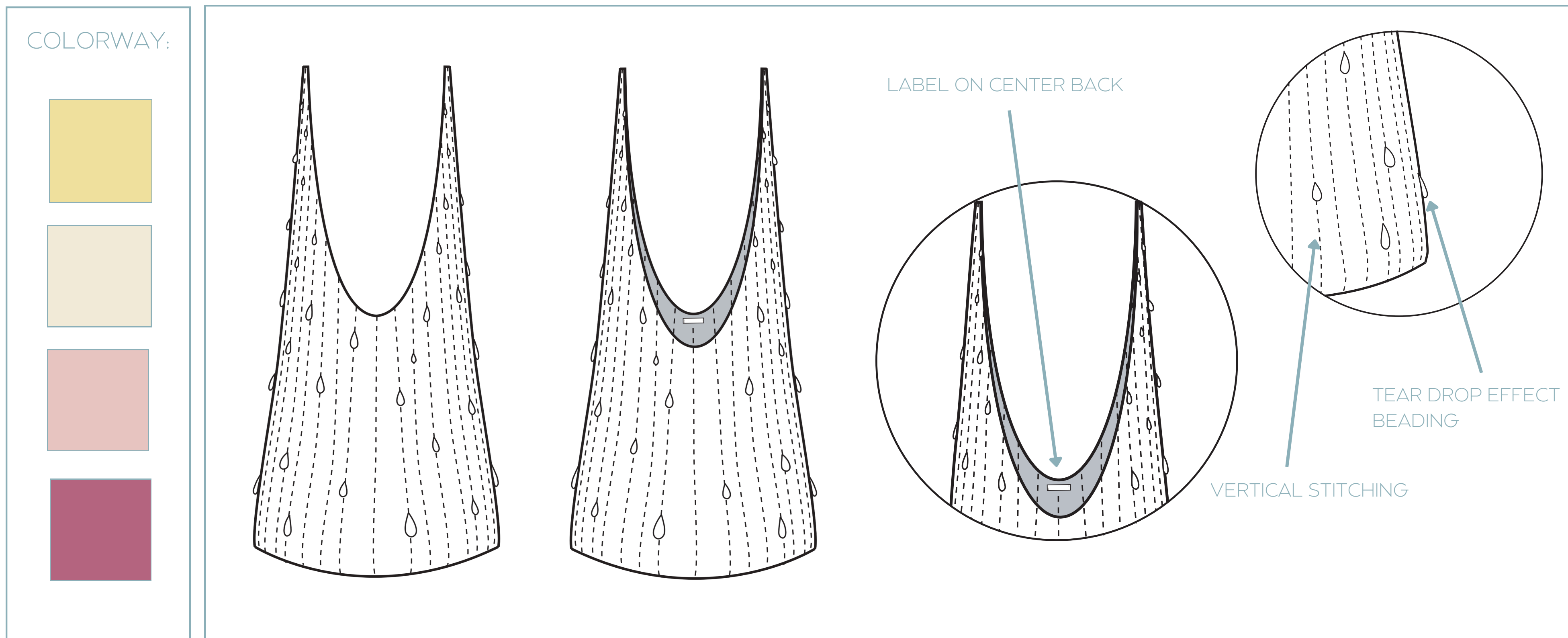

| | | | | | |
|--------------|-------------------------|----------|-----------------------|--------|--------|
| | FABRIC 1 | FABRIC 2 | ACCESSORIES: | TRIMS: | NOTES: |
| REF* | LINEN | | CLEAR TUBE BEADS | | |
| COMPOSITION* | 100% LINEN | | CLEAR TEAR DROP BEADS | | |
| WEIGHT* | | | | | |
| PLACEMENT* | BODY | | | | |
| THREAD | 100% POLYESTER DTM BODY | | | | |

| | | | | |
|--|------------------------|--|--------------------------------|---------------|
| | BRAND: A POINT OF VIEW | STYLE NAME: TOP WITH TEAR DROP EMBELLISHMENT | PATTERN: | 1ST PROTO |
| | BUYER: | STYLE NUMBERS: | SIZE RANGE: PROTO SIZE: | |
| | PRODUCT TECHNICIAN: | SEASON: SS 25 | DATE LAST MODIFIED: 25/05/2025 | STYLE DETAILS |

PRODUCT DESCRIPTION

BOAT NECKLINE TOP WITH VERTICALLY STITCHED BEADS FOR A TEAR DROP EFFECT

FRONT VIEW

BACK VIEW

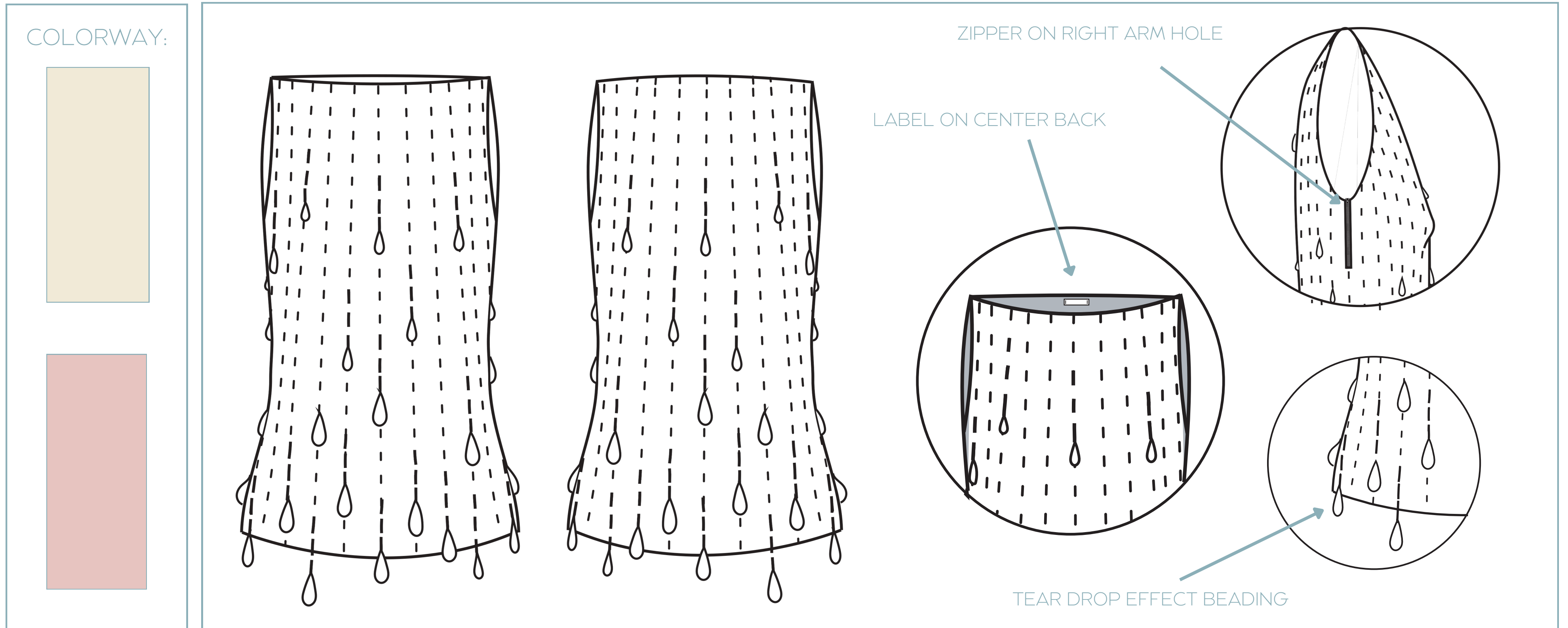

| | | | | | |
|--------------|-------------------------|----------|-----------------------|--------|--------|
| | FABRIC 1 | FABRIC 2 | ACCESSORIES: | TRIMS: | NOTES: |
| REF* | LINEN | | CLEAR TUBE BEADS | | |
| COMPOSITION* | 100% LINEN | | CLEAR TEAR DROP BEADS | | |
| WEIGHT* | | | | | |
| PLACEMENT* | BODY | | | | |
| THREAD | 100% POLYESTER DTM BODY | | | | |

| | | | | |
|--|------------------------|---|--------------------------------|---------------|
| | BRAND: A POINT OF VIEW | STYLE NAME: MAXI DRESS WITH TEAR DROP EMBELLISHMENT SLEEVES | PATTERN: | 1ST PROTO |
| | BUYER: | STYLE NUMBERS: | SIZE RANGE: PROTO SIZE: | |
| | PRODUCT TECHNICIAN: | SEASON: SS 25 | DATE LAST MODIFIED: 25/05/2025 | STYLE DETAILS |

PRODUCT DESCRIPTION

MAXI ORGANZA DRESS WITH VERTICALLY STITCHING AND SHORT SLEEVES WITH TEAR DROP EFFECT BEADING

FRONT VIEW

BACK VIEW

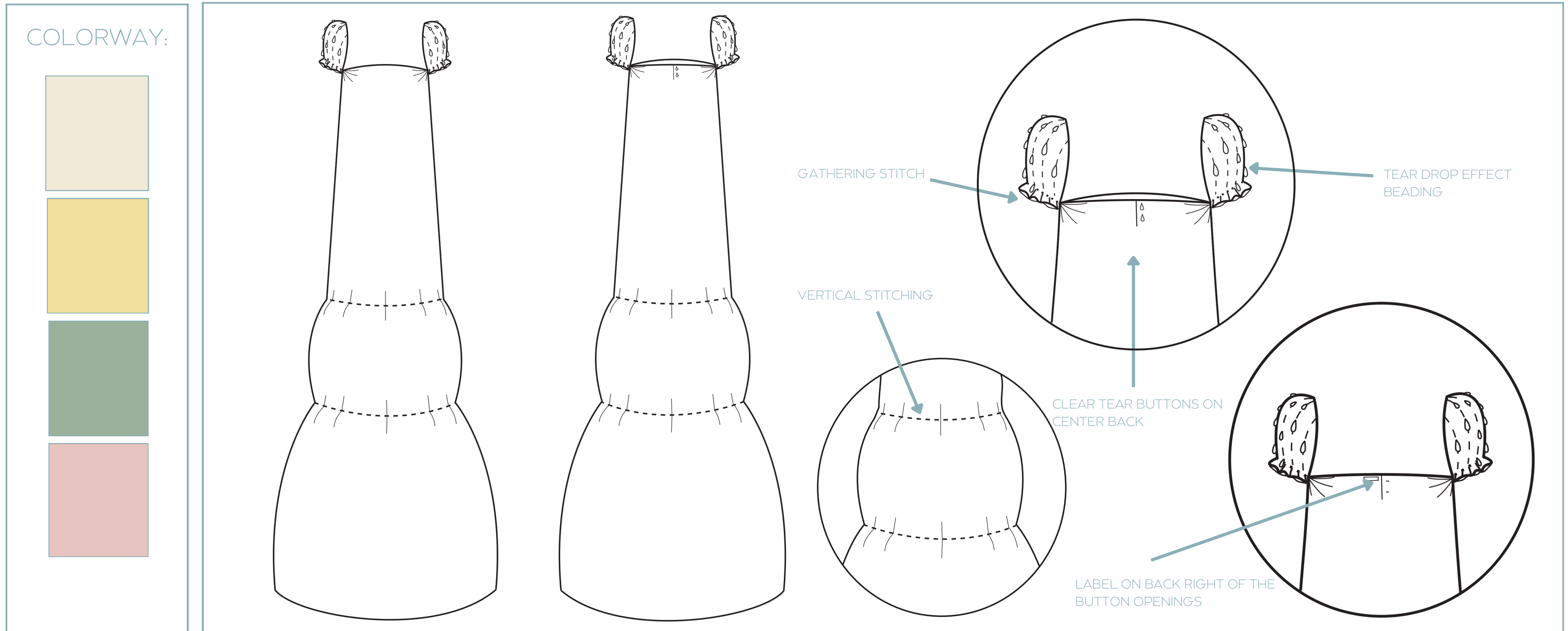

| | | | | | |
|--------------|-------------------------|----------|-----------------------|--------|--------|
| | FABRIC 1 | FABRIC 2 | ACCESSORIES: | TRIMS: | NOTES: |
| REF* | ORGANZA | | CLEAR TUBE BEADS | | |
| COMPOSITION* | 100% POLYESTER | | CLEAR TEAR DROP BEADS | | |
| WEIGHT* | | | | | |
| PLACEMENT* | BODY | | | | |
| THREAD | 100% POLYESTER DTM BODY | | | | |

| | | | | |
|--|------------------------|---|--------------------------------|---------------|
| | BRAND: A POINT OF VIEW | STYLE NAME: MINI DRESS WITH CHIFFON BRAIDS AND BEADED LINES SLEEVE DETAIL | PATTERN: | 1ST PROTO |
| | BUYER: | STYLE NUMBERS: | SIZE RANGE: PROTO SIZE: | |
| | PRODUCT TECHNICIAN: | SEASON: SS 25 | DATE LAST MODIFIED: 25/05/2025 | STYLE DETAILS |

PRODUCT DESCRIPTION

MINI DRESS WITH HORIZONTAL STITCHING AND A CUT OUT WAIST. SLEEVES ARE COMPOSED OF INDIVIDUAL CHIFFON BRAIDS AND BEADED LINES.

FRONT VIEW

BACK VIEW

COLORWAY:

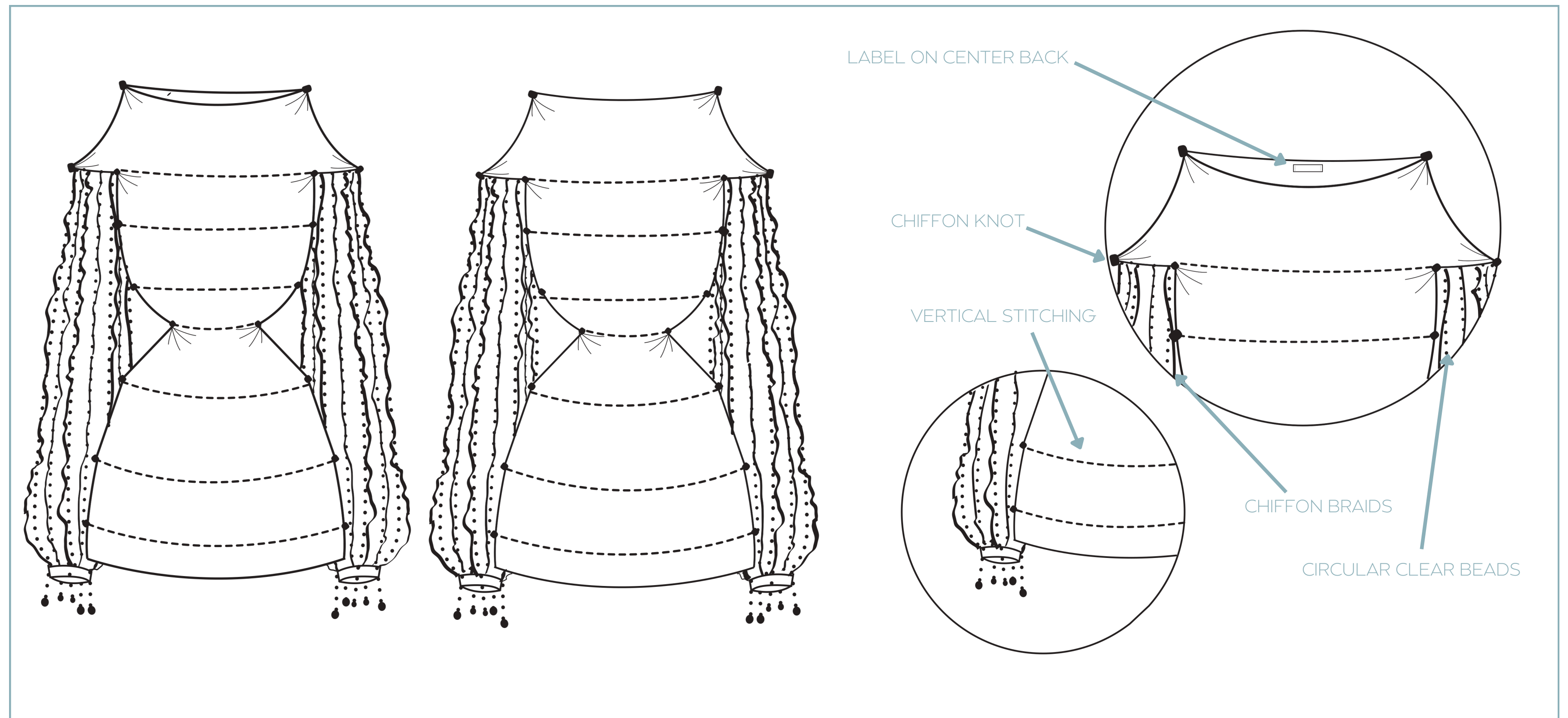

| | | | | | |
|--------------|-------------------------|----------|---------------------|--------|--------|
| | FABRIC 1 | FABRIC 2 | ACCESSORIES: | TRIMS: | NOTES: |
| REF* | CHIFFON | | CLEAR ROUNDED BEADS | | |
| COMPOSITION* | 100% POLYESTER | | | | |
| WEIGHT* | | | CHIFFON BRAIDS | | |
| PLACEMENT* | BODY | | | | |
| THREAD | 100% POLYESTER DTM BODY | | | | |

| | | | | |
|--|------------------------|---|--------------------------------|---------------|
| | BRAND: A POINT OF VIEW | STYLE NAME: CHIFFON TROUSERS WITH VERTICAL STITCHING. | PATTERN: | 1ST PROTO |
| | BUYER: | STYLE NUMBERS: | SIZE RANGE: PROTO SIZE: | |
| | PRODUCT TECHNICIAN: | SEASON: SS 25 | DATE LAST MODIFIED: 25/05/2025 | STYLE DETAILS |

PRODUCT DESCRIPTION

LIGHT CHIFFON TROUSERS WITH VERTICAL STITCHING.

FRONT VIEW

BACK VIEW

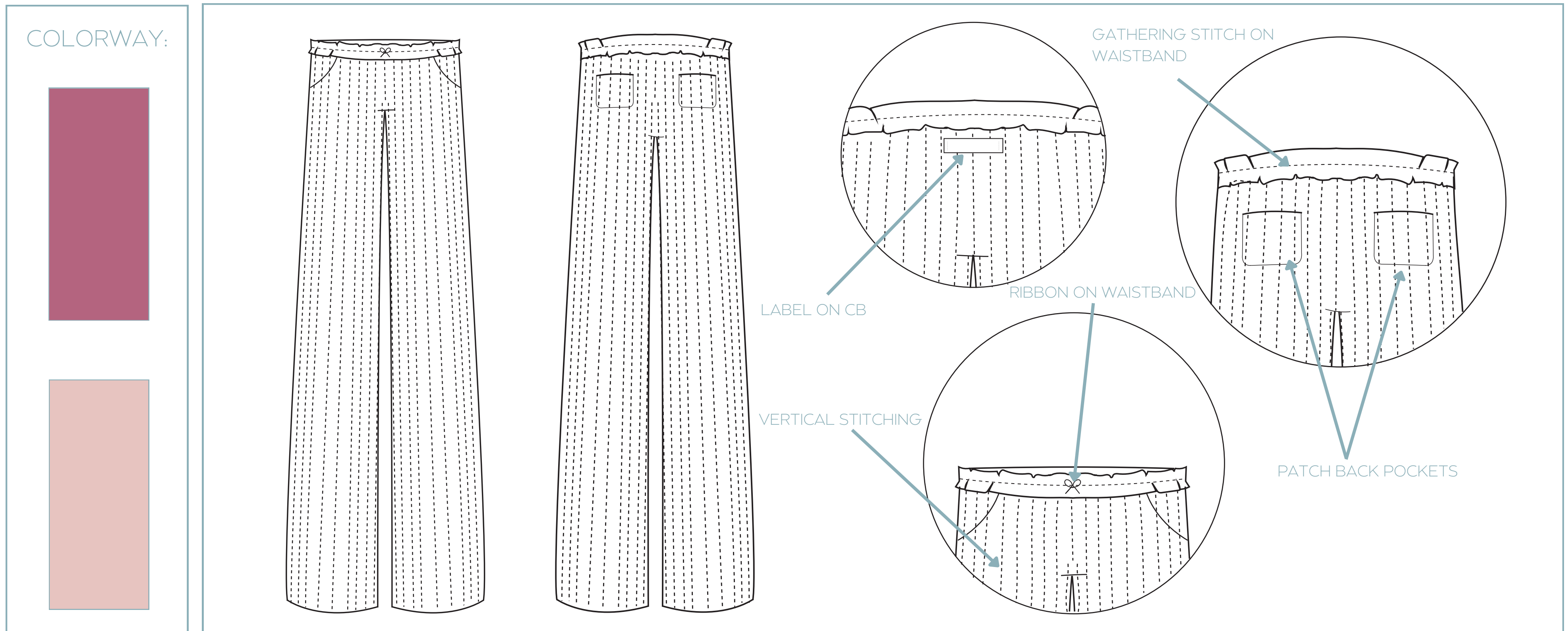

| | | | | | |
|--------------|-------------------------|----------|--------------|--------|--------|
| | FABRIC 1 | FABRIC 2 | ACCESSORIES: | TRIMS: | NOTES: |
| REF* | CHIFFON | | | | |
| COMPOSITION* | 100% POLYESTER | | | | |
| WEIGHT* | | | | | |
| PLACEMENT* | BODY | | | | |
| THREAD | 100% POLYESTER DTM BODY | | | | |